



ENTRA[®] POINT FIVE THEATER PACK

Owner's Guide



ENTRA POINT FIVE THEATER PACK OWNER'S GUIDE

Table of Contents

- 1 Introduction
- 1 Unpacking the System
- 1 Planning Your System
- 2 Placement
- 2 Wall-Mounting the Satellites
- 3 Center and Satellite Speaker Connections
- 4 Operation
- 4 Maintenance and Service
- 5 Specifications

INTRODUCTION

Infinity Entra Series

The Entra Series of loudspeakers continues Infinity's longstanding commitment to accurate sound reproduction. Our proprietary Ceramic Metal Matrix Diaphragm™ (C.M.M.D.™) drivers, precision dividing networks and rigid, well-braced enclosures combine to deliver uncompromised performance in any stereo or multichannel home theater system. In addition, Entra Series speakers, except for the powered subwoofer, are magnetically shielded for safe placement adjacent to a television.

Unpacking the System

Carefully unpack the system. If you suspect damage from transit, report it immediately to your dealer and/or delivery service. Keep the shipping carton and packing materials for future use. Open the package and verify the following contents:

- Warranty Statement

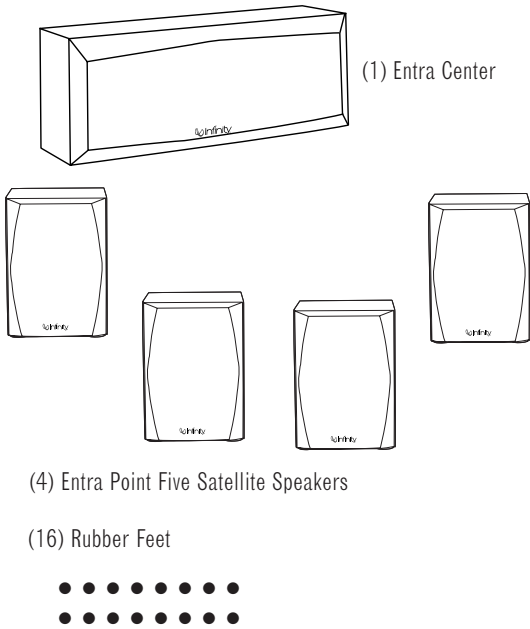

PLANNING YOUR SYSTEM

Before deciding where to best place your speakers, survey your room and study Figures 1 and 2.

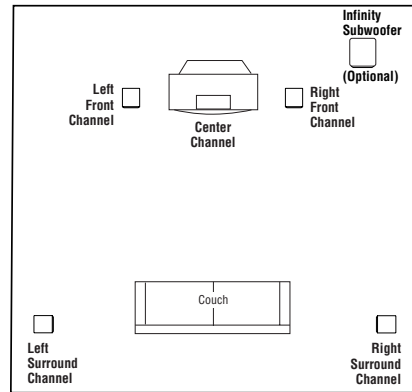

Figure 1. In this overhead view of a typical installation, satellite speakers are used to reproduce sound for the front and surround channels. The center channel reproduces sound and dialogue. The powered subwoofer provides bass for effects and music.

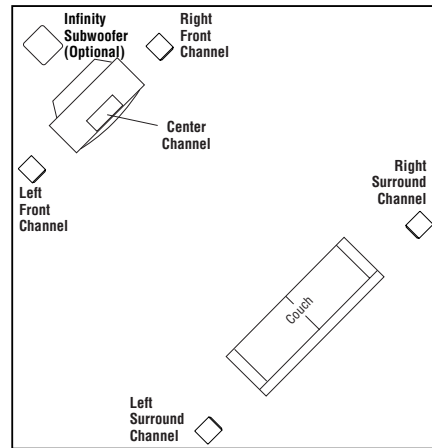

Figure 2. This figure shows an alternative layout which may be more suitable for some rooms.

PLACEMENT

NOTE: The satellite speakers can be placed directly on a shelf, or mounted on a wall using the built-in keyhole mount or optional wall brackets.

Left and Right Front Channels

For left and right front channels, place one satellite to the left and another to the right of the television, as shown in Figure 1. Since the speakers are magnetically shielded, you can place them very close to the TV without worrying about the magnetic field distorting the picture.

Center Channel

For the center channel, place the speaker directly on top of, or below, your television. Use a shelf if the television does not provide a stable platform.

Surround Channels

For left and right surround channels, place one speaker on the left and another on the right, to the side of or slightly behind the listening area. The surround speakers should be mounted at a height of between 4 feet and 7 feet.

Optional Subwoofer

Adding an Infinity powered subwoofer to the Entra Point Five Theater Pack will add the low-frequency information found in many recordings. Infinity manufactures several powered subwoofers that will deliver the impact and realism of today's music and movie soundtracks. Consult your Infinity dealer for help in determining which subwoofer is best for you. If you already own a subwoofer, consult the subwoofer's manual for proper installation and connection instructions.

WALL-MOUNTING THE SATELLITES

The Entra Point Five satellites are designed to mount directly to a wall. Each satellite speaker has a keyhole on the back. Each speaker will require (1) 1-1/2," #10 wood screw fastened to a wall stud. If a wall stud is unavailable, install an anchor appropriate for a 1-1/2," #10 screw.

NOTE: The customer is responsible for the correct selection and use of mounting hardware (available through hardware stores) that will ensure the proper and safe wall-mounting of the speakers.

Step 1.
Mark the position on the wall where you would like to place the mounting screw.

Figure 3.

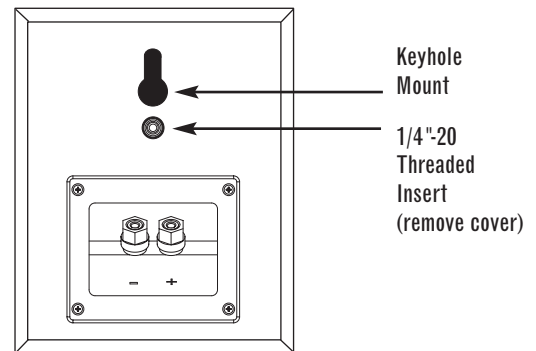

Step 2.
Fasten (1) 1-1/2," #10 wood screws to the wall using the markings placed in Step 1 as your guide. Leave a 11/16" space between the wall and screwhead. If a wall stud is not available, use an appropriate anchor.

Step 3.
Place the speaker on the wall by aligning the keyhole on the back of the speaker to the screwhead on the wall. Once positioned properly, the speaker should slide down slightly and become secure.

The Entra Point Five also allows the use of third-party wall brackets using the 1/4"-20 threaded insert located beneath the keyhole mount. Consult the wall-bracket manufacturer for selection of proper bracket.

CENTER AND SATELLITE SPEAKER CONNECTIONS

Turn Off All Power

After placing the speakers, you are ready to connect your system. First, turn off all audio-system power. Use high-quality speaker wire to make your connections. Use at least #16-gauge speaker wire with polarity coding. The side of the wire with a ridge or other coding is usually considered positive polarity (i.e., +). Also, consult the owner's manuals that were included with your amplifier or receiver to confirm connection procedures.

Satellites

Observe polarities when making speaker connections, as shown in Figure 4. Connect each + terminal on the back of the amplifier or receiver to the respective + (red) terminal on each speaker. Connect the – (black) terminals in the same way.

Important!

Do not reverse polarities (i.e., + to – or – to +) when making connections. Doing so will cause poor imaging and diminished bass response. Be certain that positive and negative wire strands are completely isolated to avoid short circuits that may damage your equipment.

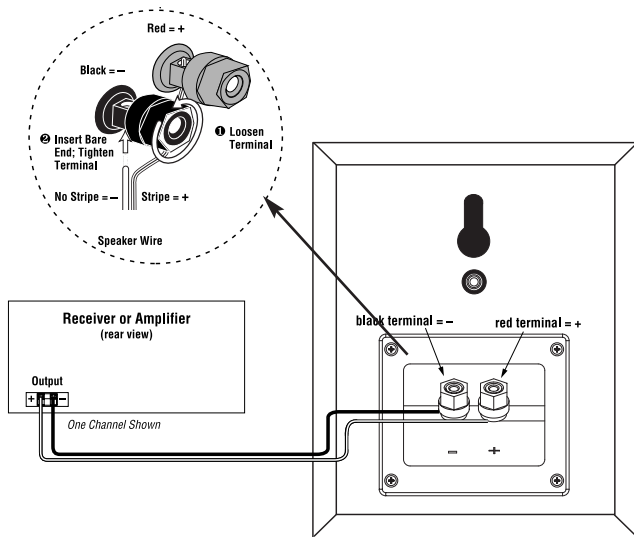

Figure 4. Wiring diagram shows polarity connections for one channel of a home theater system.

Center Channel

Observe polarities when making speaker connections, as shown in Figure 5. Connect each + terminal on the back of the amplifier or receiver to the respective + (red) terminal on the speaker. Connect the – (black) terminals in the same way.

Important!

Do not reverse polarities (i.e., + to – or – to +) when making connections. Be certain that positive and negative wire strands are completely isolated to avoid short circuits that may damage your equipment.

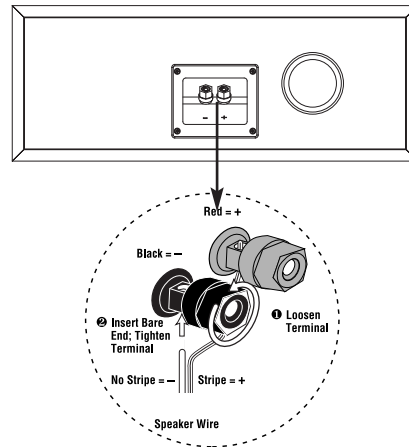

Figure 5. The satellites and center channel speaker feature terminals that can be connected in several different ways: e.g., banana plugs, spade terminals and direct wiring (as shown here).

OPERATION

Surround Modes

When using the Entra Point Five Theater Pack in a Dolby* Pro Logic* home theater system, make sure the receiver's center channel mode is set to "Normal." When using the system in a Dolby Digital or DTS® home theater system, make sure all speakers are set to "Small".

Some Dolby Digital-equipped receivers/processors offer different setup options for each source or surround mode, e.g., CD-stereo, videotape, Dolby, Pro Logic. In each case, follow your equipment's instructions to ensure that the subwoofer (if you have one) output is turned on and that the speakers are set to "Small" in each mode.

MAINTENANCE AND SERVICE

The satellite and subwoofer enclosures may be cleaned using a soft cloth, dampened with water only, to remove fingerprints or to wipe off dust.

The grilles may be gently vacuumed. Stains may be removed with an aerosol cleaner, following its instructions. Do not use any solvents on the grille.

All wiring connections should be inspected and cleaned or remade periodically. The frequency of maintenance depends on the metals involved in the connections, atmospheric conditions, and other factors, but once per year is the minimum.

If a problem occurs, make sure that all connections are properly made and clean. If a problem exists in one loudspeaker, reverse the connection wires to the left and right system. If the problem remains in the same speaker, then the fault is with the loudspeaker. If the problem appears in the opposite speaker, the cause is in another component or cable. In the event that your Entra Point Five Theater Pack ever needs service, contact your local Infinity dealer or Infinity directly at 1-800-553-3332 (only in USA) or www.infinitysystems.com for a service center near you.

SPECIFICATIONS

Entra Point Five Theater Pack

	Satellites	Center Channel
Frequency Range:	100Hz – 20,000Hz (± 3 dB)	95Hz – 20,000Hz (± 3 dB)
Recommended Amplifier Power Range:	15 – 100 watts	15 – 125 watts
Sensitivity: (2.83V @ 1 meter)	86dB	89dB
Nominal Impedance:	8 Ω	8 Ω
Crossover Frequency:	2500Hz, 24dB/Octave	2500Hz, 24dB/Octave
Midrange Driver(s):	4" C.M.M.D., magnetically shielded	Dual 4" C.M.M.D., magnetically shielded
High-Frequency Driver:	3/4" C.M.M.D., magnetically shielded	3/4" C.M.M.D., magnetically shielded
Dimensions (H x W x D):	7-5/8" x 5-5/8" x 5-1/2" (194mm x 143mm x 140mm)	6-1/2" x 17" x 5-1/4" (165mm x 432mm x 133mm)
Weight:	6 lb (2.7kg)	12 lb (5.5kg)

Infinity continually strives to update and improve existing products, as well as create new ones. The specifications and construction details in this and related Infinity publications are therefore subject to change without notice.

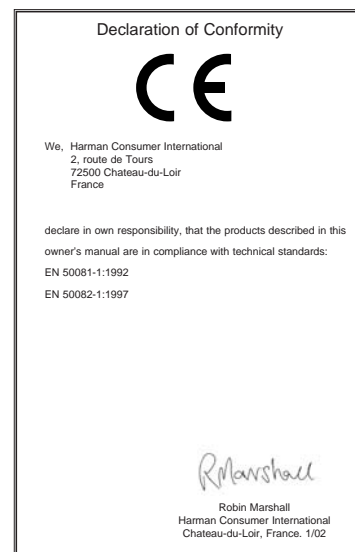



H A Harman International Company © 2002 Infinity Systems, Inc., 250 Crossways Park Drive, Woodbury, NY 11797 USA (800) 553-3332 (USA Only) www.infinitysystems.com

*Trademarks of Dolby Laboratories. DTS is a registered trademark of Digital Theater Systems, Inc.

Infinity is a registered trademark of Infinity Systems, Inc. Part No: ENTRA5THEATEROM